

RECARO

Racing shells

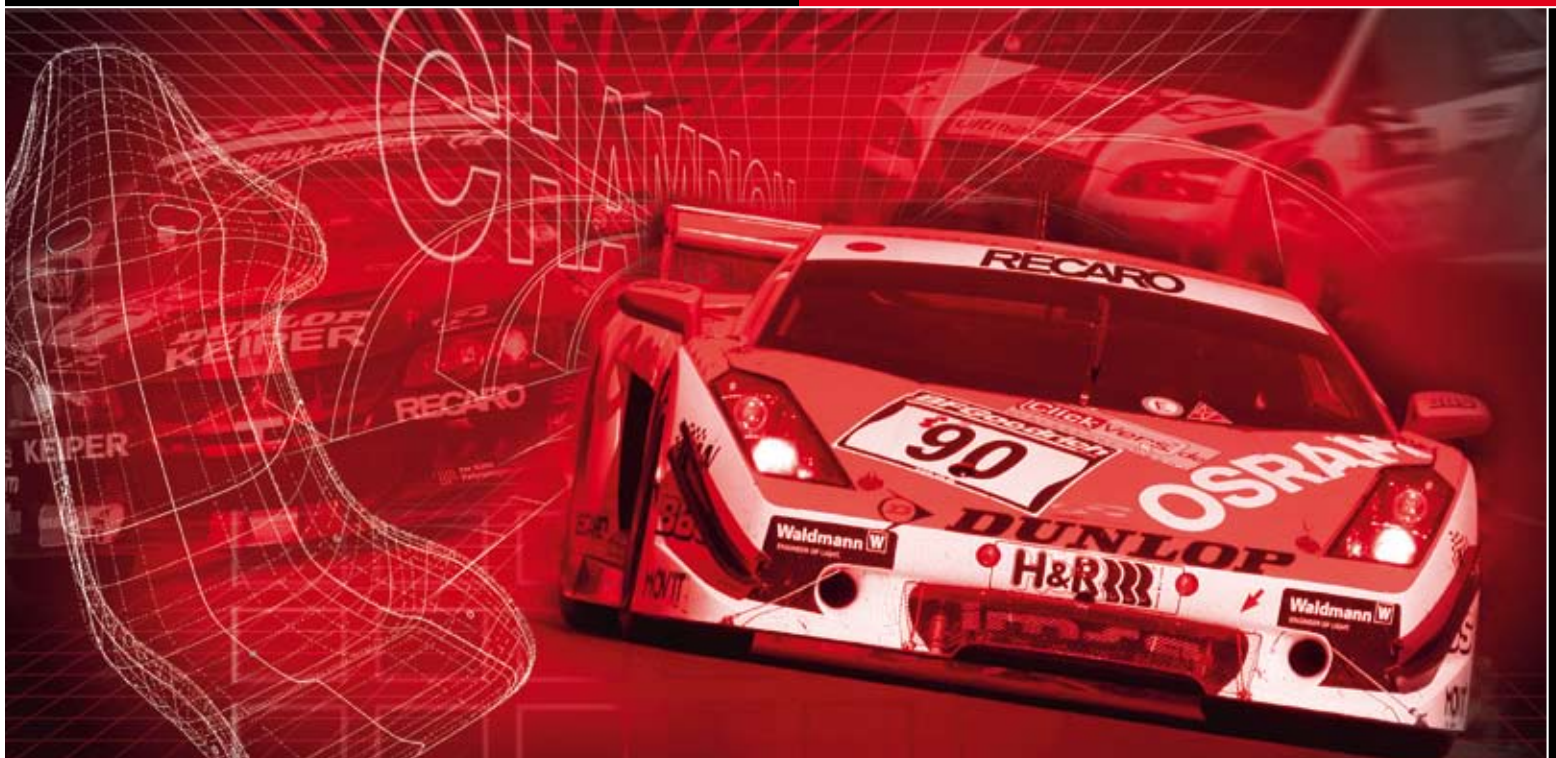

Safety, quality and excellent comfort – a new dimension in seating

Racing and Winning

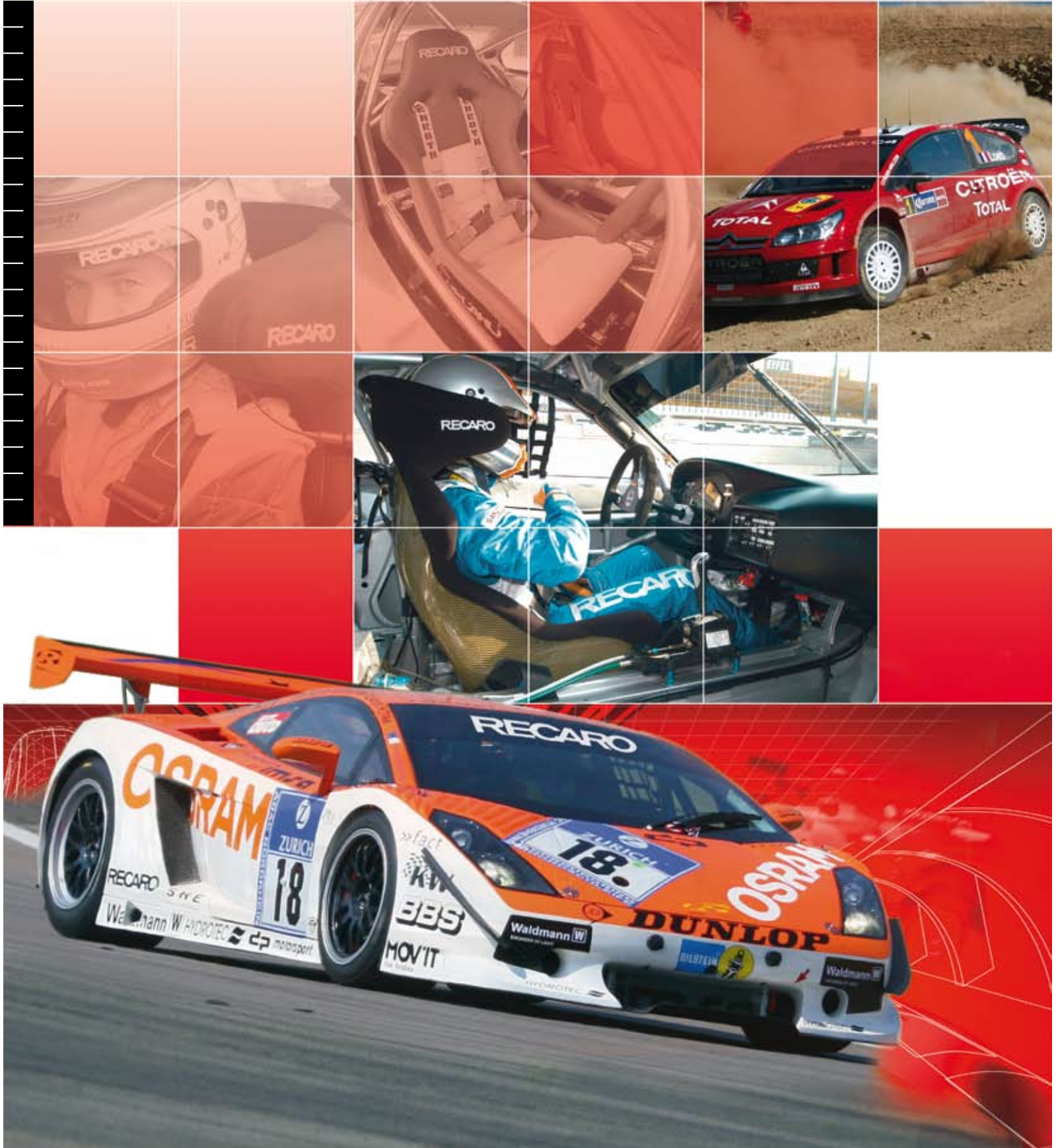



There's no substitute for experience.

This phrase doesn't only apply to drivers on a racetrack. RECARO's race shells represent 100 years of know-how and company tradition, combined with over 40 years in motorsport. Gain a head-start, rely on RECARO's unrivalled seat technology.

To be successful in motorsport requires total commitment. To make this commitment a driver must have absolute faith in the quality and dependability of his equipment. That's why decades of champions have placed their trust 100% in the safety, expertise and experience of RECARO. Our race shells offer outstanding product benefits, their superb design, unique construction, the use of high-quality materials and excellent processing - the manufacturing process combines the latest technology with traditional hand-craft, so quality is guaranteed!

RECARO produces its race shells from two special materials, either high strength, glass fibre reinforced plastic (GRP) or ultra-light Carbon-Kevlar®, which achieves the highest possible strength through its structure. When designing its seats, RECARO subjects them to the most rigorous test programme. Once approved, the finest manufacturing process, tried and tested in aircraft manufacture are used, for example, all RECARO Carbon-Kevlar® racing shells are produced in an autoclave. This process provides the shells with their extreme load-bearing

capacity, whilst maintaining the lowest possible weight. The latest in modern technology is applied to make sure the material is protected during the final processing steps. One prime example is the trimming, which is carried out by a computer-controlled high-pressure water cutter.

The latest crash tests on a wide range of shells have paid impressive testimony to the overall quality and safety of RECARO's race shells, which not only satisfy, but exceed; each and every aspect of the FIA requirements.

Often Copied but Never Equalled – Winners sit in RECARO!

Quality without compromise:

- All RECARO SPA Carbon-Kevlar® racing shells are manufactured in an autoclave.
- All RECARO racing shells are exclusively hand made.
- "Made in Germany" quality.



Feel the difference

Race to win. We'll take care of your safety.

You have absolute confidence in your ability – as we have in our seats. For decades, more top drivers and champions in all of the important national and international racing series have relied on the safety and performance of RECARO race shells. The feedback received from these champions has been integrated into our product development, which has been further enhanced in association with our own RECARO racing team.

During a race, your concentration should focus purely on driving. RECARO makes sure that's where it stays. **RECARO race shells withstand the most extreme loads, whilst their unique design offers the driver an excellent seat position and unrivalled safety in every situation. Close cooperation with drivers and race engineers gives RECARO a unique insight into the requirements of both the driver and the team, giving us a head-**

start in terms of design features, safety and seat technology, so you can also benefit from our success. Winners sit in RECARO for good reason. The host of international accolades – in the following motorsport series – speak for themselves:

- WRC
- Rallye-Raid
- DRM
- VLN – BFGoodrich Long Distance Championship
- 24-hours at Le Mans/Nürburgring/Spa
- Japan GT
- ALMS
- FIA GT

- ADAC-Procar
- LMES
- WTCC
- BTCC/DTC
- VW Polo Cup
- Ford Fiesta ST Cup
- MINI Challenge
- and many more



RECARO Furious



Specially designed shoulder support for optimum lateral hold

Full GRP Composite seat shell construction



Integrated headrest with outline embroidered logo

35 mm wider for more comfort

Designed to accept a 4-, 5- or 6-point harness

Requires optional FIA approved Steel sidemount



Accessories (at additional cost): FIA-homologated sidemounts, double locking runners (see page 18).

Great features – attractive price.

Seat constructed from GRP composite. Well-defined seat cushion and seat back bolsters offer optimum vehicle control in all driving situations.

RECARO Pole Position (FIA)



Specially designed shoulder support for optimum lateral hold

Full GRP Composite seat shell construction

Lumbar cushions for individual support of the spinal column



Integrated headrest with fully embroidered logo

Well-defined seat cushion and seat back bolsters for optimum vehicle control in all driving situations

Designed to accept a 4-, 5- or 6-point harness

Requires optional FIA approved Steel sidemount



Accessories (at additional cost): FIA-homologated sidemounts, double locking runners, seat cushions (see page 18).

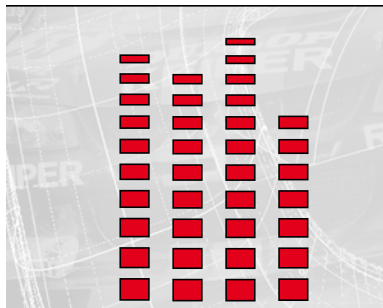

Our universal race shell for all motorsports applications.

Seat constructed from GRP composite. The pronounced seat cushion and seat back bolsters offer optimum vehicle control in extreme driving situations.



RECARO Apex



Integrated headrest with outline embroidered logo

Specially designed shoulder support for optimum lateral hold

Well-defined side support for excellent location

Full GRP Composite seat shell construction

Designed to accept a 4-, 5- or 6-point harness

Requires optional FIA approved Steel sidemount



Accessories (at additional cost):

FIA-homologated sidemounts, double locking runners (see page 18).

Great Features – Attractive Price.

Its not only the price of this entry-level GRP composite shell that makes it so attractive, it offers all the features and benefits you only get from a ,genuine RECARO‘.

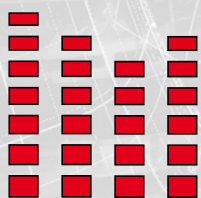

RECARO Profi SPG



Specially designed shoulder support for optimum lateral hold

Well-defined side support for excellent location

Full GRP Composite seat shell construction



Integrated headrest with fully embroidered logo

Friction grip surface in the shoulder area

Designed to accept a 4-, 5- or 6-point harness

Requires optional FIA approved Steel sidemount



Extras (at additional cost): Seat material (see page 17).

Accessories (at additional cost): FIA-homologated sidemounts, double locking runners, seat cushions (see page 18).

The choice of champions.

This professional GRP composite shell has special friction grip surfaces in the shoulder area that makes it an excellent choice for use in rallying and circuit racing.

RECARO Profi SPG XL



Specially designed shoulder support for optimum lateral hold

Friction grip surface in the shoulder and seat area

Well-defined side support for excellent location

Full GRP Composite seat shell construction

35 mm wider shell than Profi SPG



Integrated headrest with fully embroidered logo

Special belt guides to cover the widest possible range of applications

65 mm higher shell than Profi SPG

Designed to accept a 4-, 5- or 6-point harness

Requires optional FIA approved Aluminium sidemount



Extras (at additional cost): Seat material (see page 17).

Accessories (at additional cost): FIA-homologated sidemounts, double locking runners, seat cushions (see page 18).

**XL-shell
for the larger driver**

The choice of champions – especially for the larger driver.

This GRP composite shell has been specially designed for the larger driver, being 35 mm wider and 65 mm higher than the standard version and comes with larger belt guides.

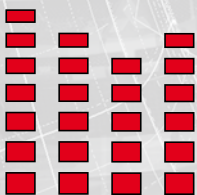

RECARO Profi SPA



Friction grip surface in the shoulder and seat area

Well-defined side support for excellent location

Ultra-lightweight shell constructed in full Carbon-Kevlar® CFK composite

Higher cushion bolsters than Profi SPG



Integrated headrest with fully embroidered logo

Specially designed shoulder support for optimum lateral hold

Designed to accept a 4-, 5- or 6-point harness

Requires optional FIA approved Steel sidemount



Accessories (at additional cost): FIA-homologated sidemounts, double locking runners, seat cushions (see page 18).

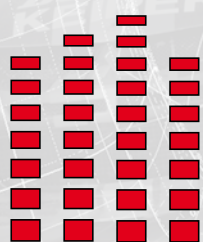

The choice of champions.

Manufactured from high-quality Carbon-Kevlar® CFK composite, this shell for the motorsport professional satisfies the most exacting requirements in both quality and safety. It has friction grip surfaces in the shoulder and seat area, distinct side padding and more pronounced lateral support than the Profi SPG model.

RECARO Pro Racer SPG HANS



The extensive headguard ensures extra protection in an accident or extreme lateral loads

Friction grip surface in the shoulder and seat area

Full GRP Composite seat shell construction

Full ergonomic support in the lumbar zone

Designed to accept a 4-, 5- or 6-point harness



Shock-absorbing foam for increased safety

Special belt guides for HANS system

HANS protection



Optimised shell geometry

Requires optional FIA approved Steel sidemount



Optimised for HANS system

More info on HANS: www.hansdevice.com

HANS systems with angle of 20° to 30° are suitable for use in RECARO HANS seats. We strongly recommend you consult an authorised dealer to select the HANS equipment.

Accessories (at additional cost):

FIA-homologated sidemounts, double locking runners, seat cushions (see page 18).

The ultimate professional racing shell for HANS system.

RECARO Pro Racer SPG HANS: Seat constructed from GRP composite. Optimum interplay between HANS system, harness, helmet and seat, is required in order for the HANS system to achieve its full potential.

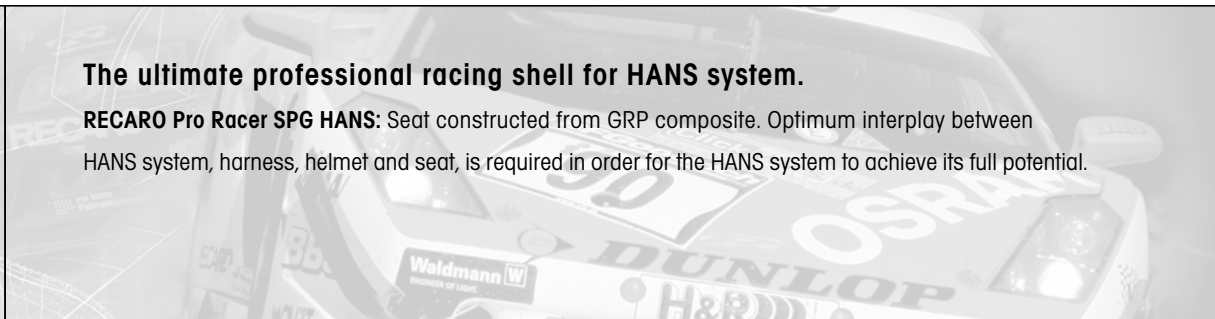
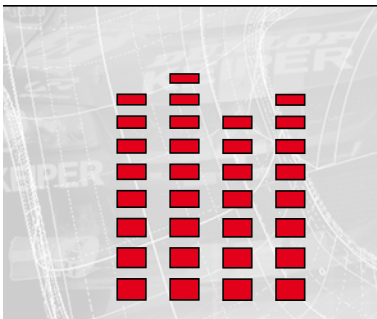

RECARO Pro Racer SPG HANS XL



The extensive headguard ensures extra protection in an accident or extreme lateral loads

Friction grip surface in the shoulder and seat area

Full GRP Composite seat shell construction

Full ergonomic support in the lumbar zone

Designed to accept a 4-, 5- or 6-point harness



Shock-absorbing foam for increased safety

Special belt guides for HANS system

HANS protection



Optimised shell geometry

Shell 35 mm wider than the Pro Racer SPG HANS

Requires optional FIA approved Steel sidemount



Optimised for HANS system

More info on HANS: www.hansdevice.com

HANS systems with angle of 20° to 30° are suitable for use in RECARO HANS seats. We strongly recommend you consult an authorised dealer to select the HANS equipment.

Accessories (at additional cost):

FIA-homologated sidemounts, double locking runners, seat cushions (see page 18).

The ultimate professional racing shell for HANS system – Specially designed for the larger driver.

RECARO Pro Racer SPG HANS XL: Specially designed for the larger driver + 35 mm width.

Seat constructed from GRP composite. Optimum interplay between HANS system, harness, helmet and seat, is required in order for the HANS system to achieve its full potential.

RECARO Pro Racer SPA HANS



The extensive headguard ensures extra protection in an accident or extreme lateral loads

Friction grip surface in the shoulder and seat area

Ultra-lightweight shell constructed in full Carbon-Kevlar® CFK composite

Full ergonomic support in the lumbar zone

Designed to accept a 4-, 5- or 6-point harness



Shock-absorbing foam for increased safety

Special belt guides for HANS system

HANS protection



Optimised shell geometry

Requires optional FIA approved Steel sidemount



Optimised for HANS system

More info on HANS: www.hansdevice.com

HANS systems with angle of 20° to 30° are suitable for use in RECARO HANS seats. We strongly recommend you consult an authorised dealer to select the HANS equipment.

Accessories (at additional cost):

FIA-homologated sidemounts, double locking runners, seat cushions (see page 18).

The ultimate professional racing shell for HANS system.

RECARO Pro Racer SPA HANS: Constructed from Carbon-Kevlar® composite.

Optimum interplay between HANS system, harness, helmet and seat, is required in order for the HANS system to achieve its full potential.

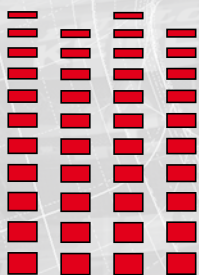

RECARO Pro Racer SPA HANS XL



The extensive headguard ensures extra protection in an accident or extreme lateral loads

Friction grip surface in the shoulder and seat area

Ultra-lightweight shell constructed in full Carbon-Kevlar® CFK composite

Full ergonomic support in the lumbar zone

Designed to accept a 4-, 5- or 6-point harness



Shock-absorbing foam for increased safety

Special belt guides for HANS system

HANS protection



Optimised shell geometry

Shell 35 mm wider than the Pro Racer SPA HANS

Requires optional FIA approved Aluminium sidemount



Optimised for HANS system

More info on HANS: www.hansdevice.com

HANS systems with angle of 20° to 30° are suitable for use in RECARO HANS seats. We strongly recommend you consult an authorised dealer to select the HANS equipment.

Accessories (at additional cost):

FIA-homologated sidemounts, double locking runners, seat cushions (see page 18).

The ultimate professional racing shell for HANS system – Specially designed for the larger driver.

RECARO Pro Racer SPA HANS XL: Specially designed for the larger driver + 35 mm width. Seat constructed from **Carbon-Kevlar® composite**. Optimum interplay between HANS system, harness, helmet and seat, is required in order for the HANS system to achieve its full potential.

RECARO Pole Position (ABE/TUV)

With ABE/TUV

ABE/TUV with 3-point seatbelt for:

- Audi:** A3 (8L, 8P), A4 (8E), A6 (4F)
- BMW:** BMW Mini (R50, Mini), BMW 3er (E46), BMW 5er (E60, E61)
- Citroën:** C2
- Ferrari:** 360 Modena (F131), 360 Spider (F131), F430
- Ford:** Fiesta (JH1), Focus (DAW, DBW, DFW, DNW, DA3, DB3), Fusion (JU2)
- Mercedes-Benz:** C-Class (W203), CLK (W209), E-Class (W211), SLK (R170)
- Opel:** Astra G, Astra G-CC, Meriva, Signum, Vectra C, Vectra CC
- Porsche:** 911 (996), Boxster (986)
- Skoda:** Octavia (1U, 1Z)
- Seat:** Altea (5P)
- VW:** Golf IV (1J), Bora (1J), Golf Variant (1J), Golf V (1K), Golf Plus (1KP), Jetta (1KM), New Beetle (9C), Passat (3C), Polo (9N), Touran (1T)

Further information on the individual vehicles can be obtained from your specialist dealer.

Notice: RECARO Sidemounts and vehicle-specific baseframe required at additional cost.



Integrated headrest for reliable head protection

Seat shell manufactured from GRP Composite

Specially designed shoulder support for optimum lateral hold

The latest cover variants in attractive designs

Lumbar cushions for individual support of the spinal column

Belt slots specially modified allowing use of standard 3-point seat belt

ABE/TUV sidemounts aluminium (option)



ABE/TUV sidemounts steel (option)



No FIA-homologation

Extras (at additional cost): Coverings (see page 18), specified seat material.

Note: Seat must be fitted by an authorised dealer, use of child seats not permitted, side airbag omitted.

Accessories (at additional cost): Sidemounts, double locking runners, seat cushion (see page 18), Baseframes.

The only race shells with ABE/TUV approval.

Pure sports – the RECARO Pole Position with ABE/TUV. Turn your car into a luxury “race vehicle” with our distinctive shell shape and a choice of cover materials. The only race shell to gain the coveted ABE/TUV approval, designed specifically for use on both the track and road, the ultimate trackday seat. ABE/TUV approved for the specified vehicles. **Additional vehicles soon to be released.**

RECARO Pole Position Carbon (ABE/TUV)

NEW!
available at
4th Quarter 2008!

ABE/TUV with 3-point seatbelt for:
see RECARO Pole Position (ABE)

Ultra-lightweight shell constructed in full
Carbon-Kevlar® CFK composite



Lightweight construction: Seat weight
4.5kg. With sidemounts and baseframe
total weight approx. 10kg



Integrated headrest for
reliable head protection

The latest cover variants
in attractive designs

Specially designed
shoulder support for
optimum lateral hold

Lumbar cushions for individual
support of the spinal column

Belt slots specially modified allowing
use of standard 3-point seat belt

ABE/TUV sidemounts aluminium (option)



ABE/TUV sidemounts steel (option)



No FIA-homologation

Extras (at additional cost): Coverings see page 18, specified seat material.

Note: Seat must be fitted by an authorised dealer, use of child seats not permitted, side airbag omitted.



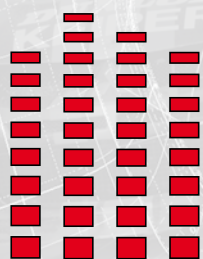







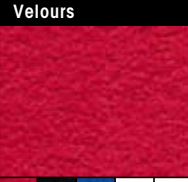

Accessories (at additional cost): Sidemounts, double locking runners, seat cushion (see page 18), Baseframes.



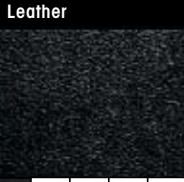

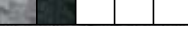
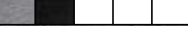

The sporty lightweight seat in full carbon – with ABE/TUV.

The RECARO Pole Position Carbon (ABE/TUV) – made of lightweight Carbon-Kevlar® material. With a weight of only 4.5kg, this racing shell offers excellent lateral support, better performance and less fuel consumption. ABE/TUV approved for the specified vehicles, (see RECARO Pole Position (ABE/TUV).

Cover choice

RECARO Coverings						
Velours	Artista	Nardo	Saturn	Dinamica Suede	Ambla-Leather	Leather
						
						
Velours: The robust and easy-care material that is also used to cover the RECARO racing shells for motorsport.	Artista: The timelessly elegant material for refined visual appearance in the vehicle interior. Guarantees longevity and durability.	Nardo: In combination with the Artista covers, these extremely durable materials ensure longevity of the side bolsters.	Saturn: The 3D effect, rubber-burled cover ensures striking visual appearance and effectively prevents slipping in the seat.	Dinamica Suede: The exclusive, suede-effect cover is highly durable and easy-care. Makes for a high-quality and sporty ambience in the vehicle.	Ambla-Leather: RECARO's artificial leather is a high-quality alternative to real leather. Highly-durable and easy-care.	Leather: RECARO's leather is a high-quality natural product and satisfies exacting requirements for the vehicle interior.











RECARO Profi SPG			RECARO Profi SPG XL		
Fabrics (Series)			Fabrics (Series)		
					
Velour black	Velour blue	Velour red	Velour black	Velour red	

RECARO Pole Position (FIA)			
Fabrics (Series)			
			
Velour black	Velour blue	Velour red	Leather black

RECARO Pro Racer SPG HANS and HANS XL, Pro Racer SPA HANS and HANS XL, Profi SPA, Apex, Furious				
Fabrics (Series)				
				
Velour black	Velour black	Velour black	Velour black	Velour black

Cover choice/Accessories

RECARO Pole Position (ABE/TUV), Pole Position Carbon (ABE/TUV)*

Fabrics (Series)*			Fabrics	Ambla-Leather/Suede-effect			
							
Velour black*	Velour blue*	Velour red*	Nardo black*	Ambla-Leather black	Ambla-Leather black	Ambla-Leather black	
			Artista black*	Dinamica Suede red	Dinamica Suede blue	Dinamica Suede black	
Ambla-Leather/Suede-effect			Leather				
			<p>* The RECARO Pole Position Carbon (ABE) is only available in the cover options Velours black, blue, red, Nardo black/ Artista black and in leather.</p>				
Ambla-Leather black	Ambla-Leather black	Leather black*					
Dinamica Suede beige	Dinamica Suede silver						

Accessories RECARO racing shells

			
Gross weight: 1.1kg	Gross weight: 2.6kg	Gross weight: 2.0kg	Gross weight: 3.1kg
			
Aluminium ABE/TUV sidemount for Pole Position (ABE/TUV) and Carbon. FIA approved for Profi SPG XL & Pro Racer SPA HANS XL	Steel ABE/TUV sidemount for Pole Position (ABE/TUV). FIA approved for Pro Racer SPG HANS XL	Steel sidemount for Apex, Profi SPG, Profi SPA, Pro Racer SPG/SPA HANS	Steel sidemount for Pole Position (FIA) & Furious
Gross weight: 2.5kg			
Double locking runners (for all racing shells)	Seat cushion for RECARO Pro Racer SPG/SPA HANS , height approx. 25 mm (only in black nylon velour)	Seat cushion for RECARO Profi SPA, Pro Racer SPG/SPA HANS , height approx. 55 mm (only in black nylon velour)	Seat cushion for RECARO Profi SPG and Pole Position (only in black nylon velour)
			
HANS protection (see pages 11 to 14)			

RECARO racing shells

RECARO Pro Racer SPG HANS

Gross weight: 10.0kg

RECARO Pro Racer SPA HANS

Gross weight: 6.5kg

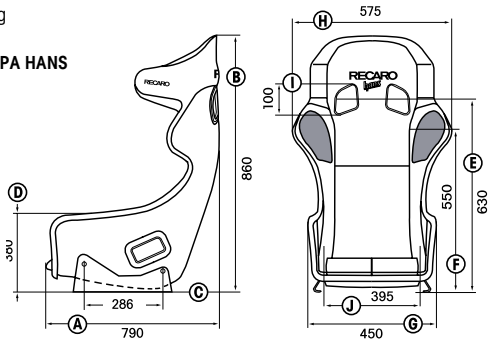

RECARO Pro Racer SPG HANS XL

Gross weight: 10.0kg
+ 35 mm width

RECARO Pro Racer SPA HANS XL

Gross weight: 7.0kg
+ 35 mm width

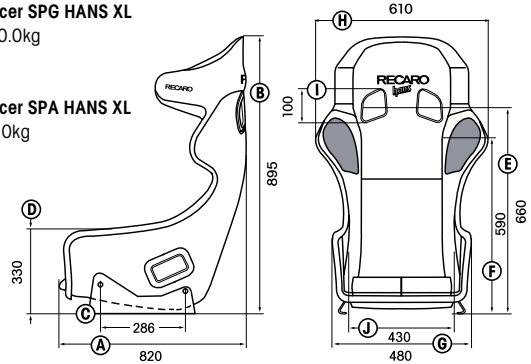

RECARO Profi SPG

Gross weight: 6.5kg

RECARO Apex

Gross weight: 6.5kg

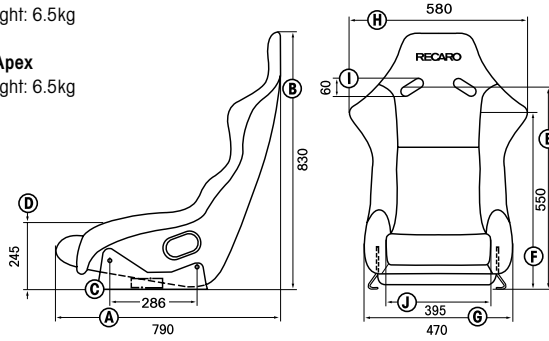

RECARO Profi SPA

Gross weight: 5.5kg

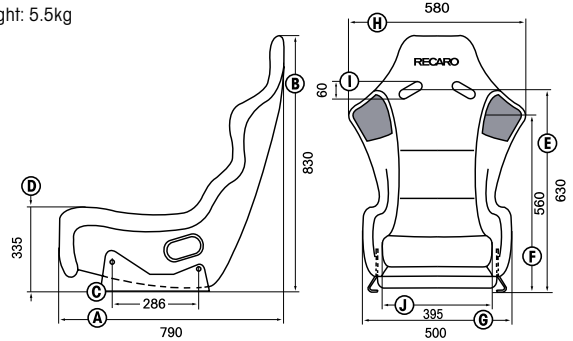

RECARO Profi SPG XL

Gross weight: 10.0kg

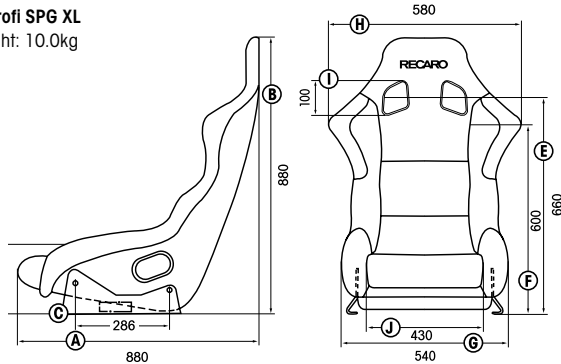

RECARO Furious

RECARO Pole Position (ABE/TUV)

RECARO Pole Position (FIA)

Gross weight: 7.0kg

RECARO Pole Position Carbon (ABE/TUV)

Gross weight: 4.5kg

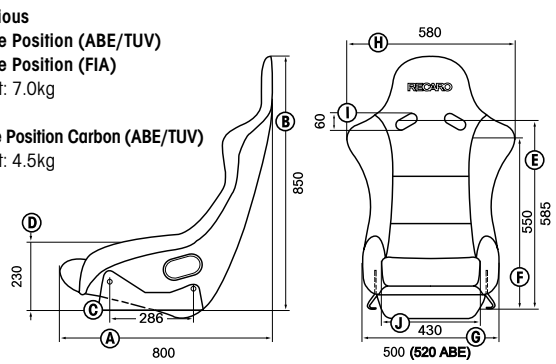

- Dimensions in mm
- Gross weight of shell (excluding sidemounts, double locking runner, etc.)
- RECARO racing shells can be individually fitted to nearly all racing cars
- With the exception of FIA/ASN-approved events, not approved for use on public roads. Except Pole Position (ABE/TUV) and Pole Position Carbon (ABE/TUV)
- RECARO Pole Position (ABE/TUV), Pole Position Carbon (ABE/TUV) has a general operating licence
- FIA-homologation 8855-1999 only valid in conjunction with the specified RECARO Adapter
- Production specific weight differences are permitted
- **RECARO's sidemount adapter's are designed to give a constant width between hole centres of 406 mm, irrespective of the different seat designs and widths (Note: correct sidemount adapter must be used)**

- A:** Seat depth
- B:** Seat height
- C:** Dimension adapter fixing points
- D:** Height dimension for thigh protection
- E:** Dimension from lower edge adapter to centre seat belt slot
- F:** Dimension from lower edge adapter to widest shoulder point
- G:** Dimension outer seat width
- H:** Maximum shoulder width dimension
- I:** Harness slot dimension
- J:** Absolute seat width of racing shell with cushion and covering

RECARO



RECARO UK Ltd.
Holly Farm Business Park
Honiley, Warwickshire CV8 1 NP
Phone: +44 (0) 845 260 8950, Fax: +44 (0) 845 260 8960
Internet: www.recaro.com, E-mail: info@recaro.co.uk

Id.-No. 7216773 • Status 10/08 • >> fact | factnet.de
RECARO® RECARO Pole Position® are registered trade marks of RECARO GmbH & Co. KG. We reserve the right to make modifications in technology, colour, form and design. No liability for printing errors.

Leadplant:
RECARO GmbH & Co. KG
Stuttgarter Straße 73, D-73230 Kirchheim/Teck
Telefon: +49 (0) 70 21/93-52 08, Telefax: +49 (0) 70 21/93-53 39
Internet: www.recaro.com, E-Mail: info@recaro.com

RECARO GmbH & Co. KG
Competence Center Child Safety
Gutfenbergstraße 2, D-95352 Marktkeugast
Telefon: +49 (0) 92 55/77-0, Telefax: +49 (0) 92 55/77-13
Internet: www.recaro.com, E-Mail: info@recaro.com

 KeiperRecaro Group