

Installation and Modification Instructions

Boxster (981)

33/12 EN 2601

2

Feb 11, 2016

The present document was valid at the time of print. A later version may be available online

Sports exhaust system (I-no. XLF)

Tools

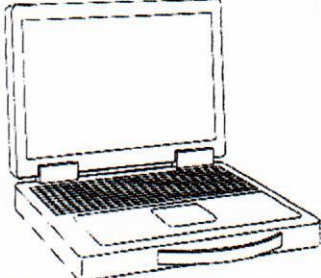
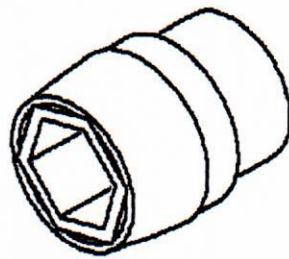
Designation	Type	Number	Description
PIWIS Tester II	Special tool	9818	<div style="border: 1px solid black; padding: 5px;"> 03  9818 000 721 981 80 </div>
Socket-wrench insert	Special tool	P 300	<div style="border: 1px solid black; padding: 5px;"> 44  P 300 000 721 300 00 </div>
Assembly tool	VW tool	T10118	

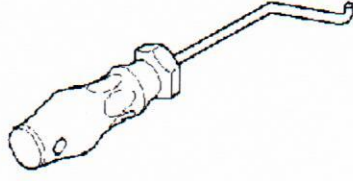
				57  T10118
--	--	--	--	---

Model year:

as of 2013

Situation:**Retrofitting****Restrictions:**

- **ONLY** together with sports tailpipe (I-no. XLS).
- In Russia (C38): **ONLY** for Boxster S (3.4-litre engine)
- In China (C33), Korea and Taiwan: **ONLY** together with Porsche Doppelkupplung (PDK) (I-no. 250).

Engine Types:

MA122 = 2.7 l – Boxster

MA123 = 3.4 l – Boxster S

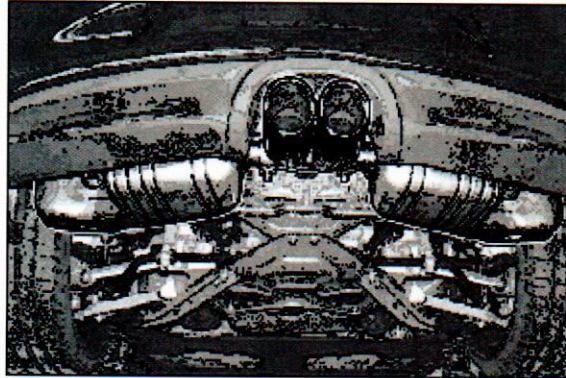
**Notes:**

The sports exhaust system is activated and deactivated using the new switch console with the additional "Twin tailpipe" button. The sports exhaust system is also activated by pressing the "Sport" and "Sport Plus" buttons. The sports exhaust system can be switched off separately in these modes using the "Twin tailpipe" button.

The switch console (combined switch) is a repair kit and must also be ordered. The repair kit contains the main body, the required buttons and the trims. The new switch console is assembled in accordance with the new vehicle equipment.

Engine power and exhaust behaviour of the vehicle are not affected. The sports exhaust system is also available ex-works for new vehicles by requesting optional equipment "XLF".

Part Nos.:**981.044.200.00**

→ Sports exhaust system WITH sports tailpipe for Boxster, set

981.044.200.04 → Sports exhaust system WITH sports tailpipe for Boxster S, set

981.044.200.01 → Sports exhaust system WITHOUT sports tailpipe, set

Also order the following:

991.613.961.03.DML Combined switch (switch console)

Parts List:

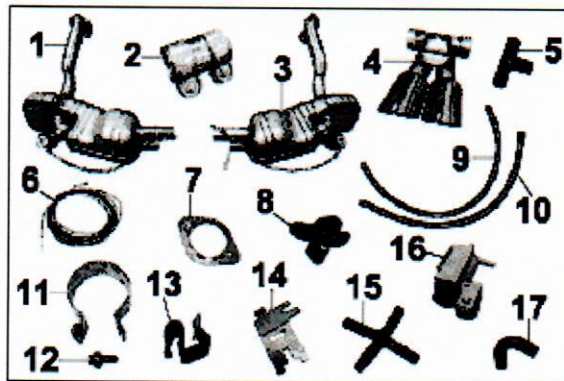

Figure 2

981.111.921.02	1 x	Rear silencer, left -1-
981.111.280.00	1 x	Clamp -2-
981.111.922.02	1 x	Rear silencer, right -3-
981.111.961.00 ¹⁾	1 x	Sports tailpipe -4-
981.111.961.01 ²⁾	1 x	Sports tailpipe (not shown)
06E.133.794	1 x	T-piece -5-
981.612.905.00	1 x	Wire harness -6-
981.111.113.00	2 x	Seal -7-
999.651.360.01	4 x	Fixing clip -8-
981.111.049.00	1 x	590-mm steel flexi-pipe -9-
900.918.005.40	1 x	Tekalan line, 5.0 x 1.0 x 1,000 mm -10-
981.111.281.01	2 x	Clamp -11-
900.385.001.02	2 x	Torx screw, M8 x 20 -12-
3D0.971.939.B	1 x	Fixing clip (transmission) -13-
981.111.989.00	1 x	Change-over valve holder -14-

928.573.729.05	1 x	Distributing piece, 4-way -15-
7PP.906.270	1 x	Change-over valve -16-
928.574.717.05	2 x	Protective tube -17-
900.910.003.03	4 x	Hexagon nut, M8 (not shown)
999.141.047.01	4 x	Torx screw, M10 x 28 (for securing seat, not shown)
928.573.727.05	1 x	Distributing piece, 3-way (Y-piece, not shown)
N 020.904.4	15 x	Tie-wrap (not shown)
999.507.206.40	2 x	Combination holder (not shown)

1) ONLY contained in set 981.044.200.00.

2) ONLY contained in set 981.044.200.04.

Materials:

000.043.004.82	1 x	Optimol-HT mounting paste
— — —		Rust solvent, commercially available, e.g. WD40

Notes:

Identifying features when installed:

A part number and the Porsche logo are shown on the rear silencers and tailpipe.

The respective legal regulations must be observed in the various countries.

For European Union (EU) member states:

The sports exhaust system described here is contained in the EU general certification of 981 vehicles as of e13*2007/46*1185*01.

Applicable only in Germany:

The PIWIS information system includes a relevant excerpt from the EU type approval system. This excerpt must be used by the respective Porsche Centre to confirm that the components were fitted in accordance with regulations, and must be handed over to the customer.

The installed/added components do not have to be approved in accordance with § 19 or § 21 of the German Road Traffic Type Approval Law (StVZO) and the vehicle registration documents do not need to be modified. However, the excerpt confirming that components were installed according to regulations must always be kept in the vehicle.

Tools:

PIWIS Tester II 9818

Assembly tool T10118

Socket-wrench insert P300

Assembly:

1 Preparatory work.

1.1 Move convertible top to service position. → 61011N Convertible-top service position

- 1.2 Remove engine compartment lid. → *557819 Removing and installing engine compartment lid*
- 1.3 Remove inner door sill trim on the left. → *680519 Removing and installing inner door sill trim*
- 1.4 Remove left front seat. → *720119 Removing and installing front seat*
- 1.5 Remove trim panel for rear-wall sound absorber. → *703119 Removing and installing trim panel for rear wall*
- 1.6 Loosen seat belt mount in the B-pillar sill area.
- 1.6.1 Open the cap **-1-** .

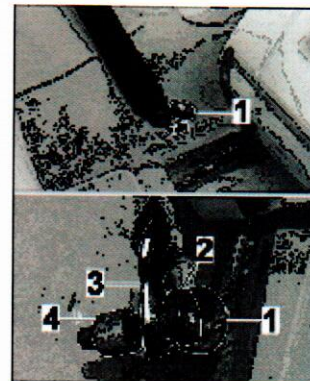

Figure 3

- 1.6.2 Unscrew cheese head bolt **-2-** and remove seat belt mount **-3-** and spacer sleeve **-4-** .
- 1.7 Remove side trim panel at the left. → *707519 Removing and installing side trim panel*
- 1.8 Remove and install rear luggage compartment trim. → *700619 Removing and installing rear luggage compartment trim panel*
- 1.9 Loosen parking brake control unit **-1-** .

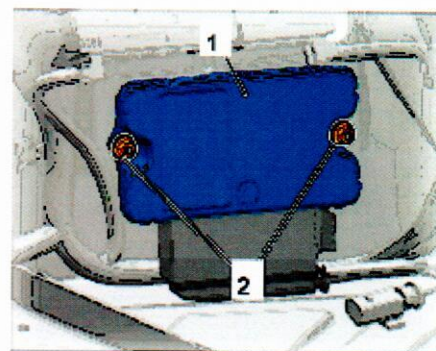

Figure 4

- 1.9.1 Screw off fastening nuts **-2-** .
- 1.9.2 Pull parking brake control unit off the studs.
- 1.10 Remove moulded part **-1-** .

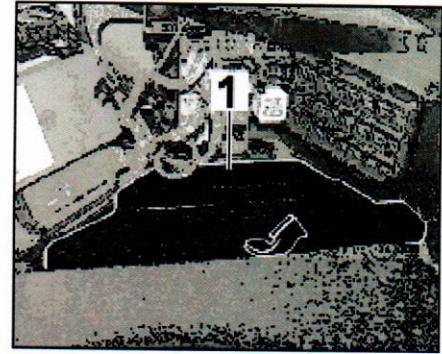

Figure 5

1.11 Loosen relay carrier in luggage compartment at the right.

1.11.1 Release electric plug connection **-arrow a-** and pull it off **-arrow b-**.

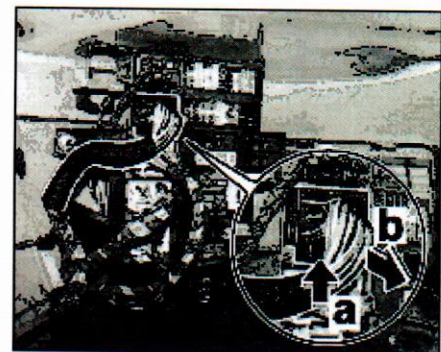

Figure 6

1.11.2 Unscrew fastening nuts **-2-** and pull relay carrier for luggage compartment at the right **-1-** off the studs and set it down.

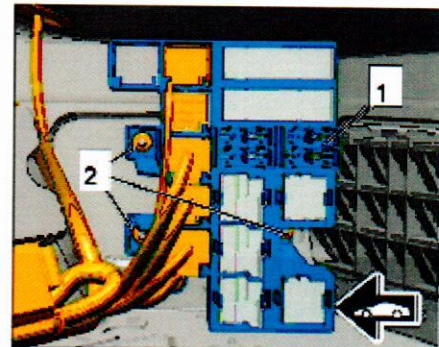

Figure 7

2 Install electric wire harness.

2.1 Secure electric wire harness to the auxiliary line.

2.2 Route electric wire harness as follows:

Passenger compartment → along standard wire harness in passenger compartment at the left → cable duct → convertible-top compartment → relay carrier in luggage compartment at the right

2.2.1 Route electric wire harness **-1-** from the rear-end electronics control unit position **-2-**, along wire harness in passenger compartment at the left to the cable duct **-3-**.

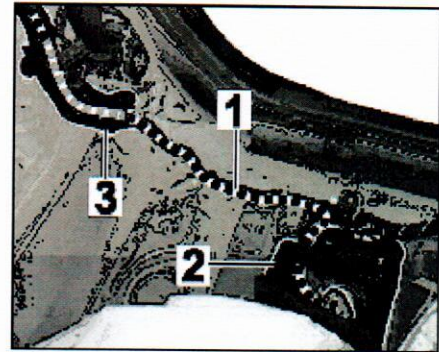

Figure 8

- 2.2.2 Route electric wire harness **-1-** through the body **-2-** to the convertible-top compartment. Lift up insulating mat **-3-** to do this.

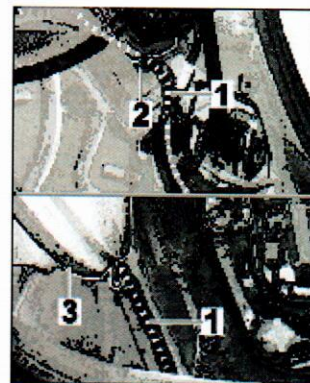

Figure 9

- 2.2.3 Route electric wire harness **-1-** along the standard wire harness to the relay carrier in the luggage compartment at the right.

- 2 - Digital engine electronics (DME) control unit
- 3 - Relay carrier in luggage compartment at the right
- 4 - Parking brake control unit



Figure 10

- 2.3 Use tie-wraps to secure electric wire harness to existing lines or components without tension and so that no chafing occurs.
- 2.4 Connect electric wire harness to the rear-end electronics control unit.
- 2.4.1 Shorten BK/YE line and crimp together using a socket contact.
- 2.4.2 Fold carpet **-arrow-** aside.

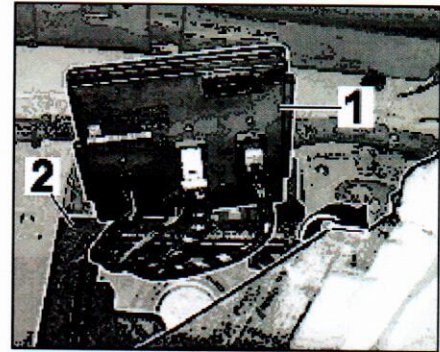

Figure 11

2.4.3 Remove rear-end electronics control unit **-1-** from the foam holder **-2-** and turn it until the plug connections are accessible.

2.4.4 Release electric plug connection **-2-** (blue) by pressing the locking mechanism **-arrow-** and swivel the clip **-1-** upwards **-arrow-**.



Figure 12

2.4.5 Press down the locking mechanism **-arrow-** and slide the grey plug socket **-1-** out of the plug carrier **-2-**.

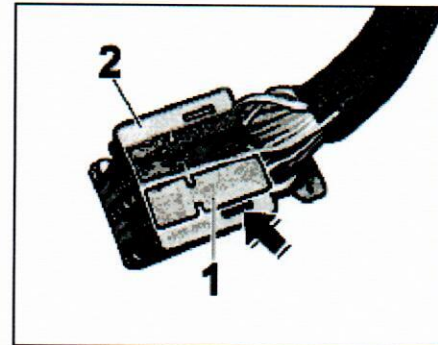

Figure 13



Information

Ensure socket contact is seated securely.

2.4.6 Insert socket contact **-1-** into chamber A2 of the grey plug socket **-2-**.

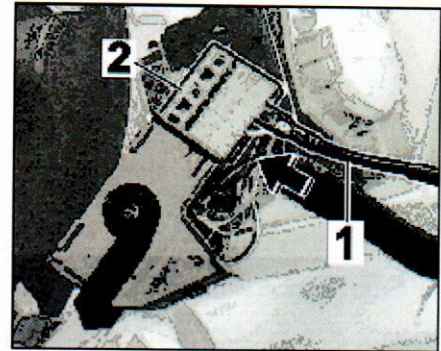

Figure 14

- 2.4.7 Slide grey plug socket **-1-** into the plug carrier **-2-** until the locking mechanism **-arrow-** engages.

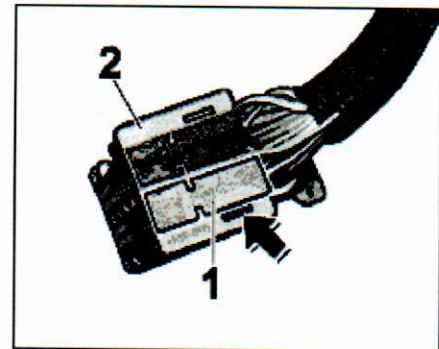

Figure 15

- 2.4.8 Connect electric plug connection **-2-** and swivel the clip **-1-** downwards.



Figure 16

- 2.4.9 Insert rear-end electronics control unit into the foam holder.

- 2.4.10 Fold back the carpet.

- 2.5 Connect BK/YE line to the black 17-pin connector socket (engine pre-wiring X31).

- 2.5.1 Release pin connector socket **-arrow a-** and pull it out of the relay carrier in the luggage compartment at the right **-1-** (**-arrow b-**).

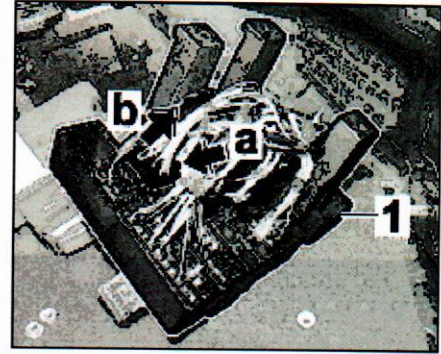

Figure 17

- 2.5.2 Release secondary lock on pin connector socket **-arrow-**.



Figure 18



Information

Ensure socket contact is seated securely.

- 2.5.3 Insert pin contact **-1-** into chamber 5 of the pin connector socket **-2-**.

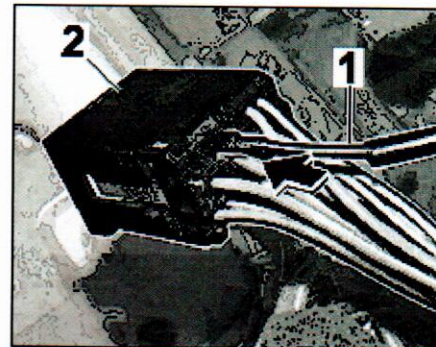

Figure 19

- 2.5.4 Lock secondary lock.
- 2.5.5 Insert pin connector socket **-1-** into the relay carrier in the luggage compartment at the right **-2-** until the locking lug locks with an audible click.

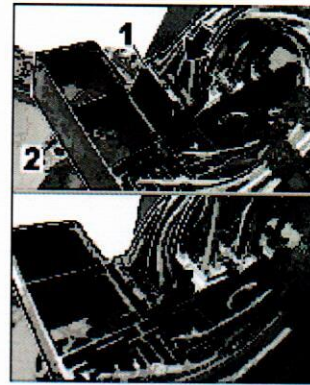

Figure 20

3 Concluding work for installing wire harness.

3.1 Install relay carrier in luggage compartment at the right.

3.1.1 Position relay carrier in luggage compartment at the right
-1- on the studs. Tighten fastening nuts **-2-**.
 → **Tightening torque: 9.7 Nm (7.5 ftlb.)**

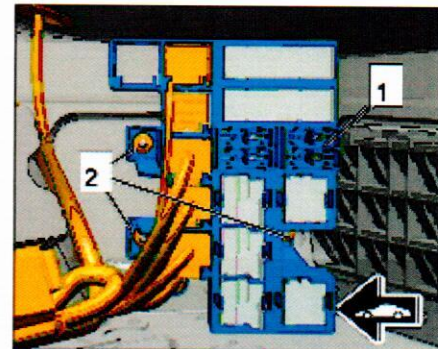

Figure 21

3.1.2 Connect electric plug connection.

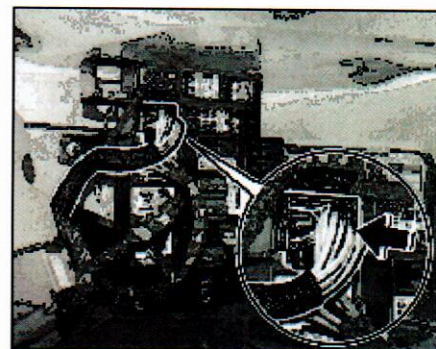

Figure 22

3.2 Secure parking brake control unit **-1-**.

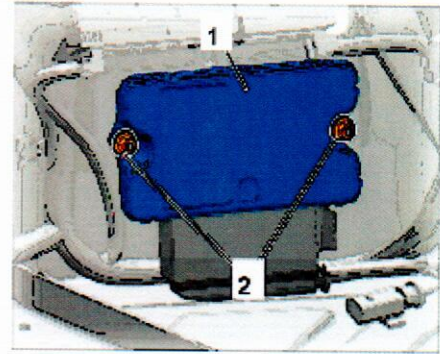

Figure 23

3.2.1 Position parking brake control unit on the studs.

3.2.2 Tighten fastening nuts -2- .

3.3 Fit moulded part -1- .

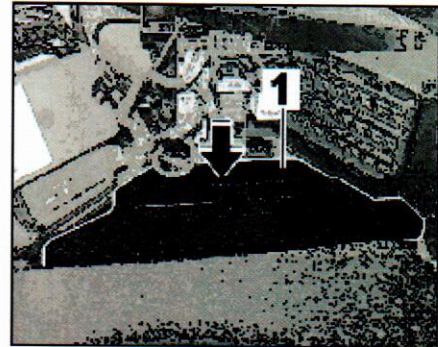

Figure 24

4 Remove rear silencers. → 263319 *Removing and installing rear silencer*



Information

Insert vacuum line at least 10 mm into the steel flexi-pipe.

5 Assemble vacuum lines.

5.1 Connect vacuum lines as shown.

5.1.1 **Vehicles with manual transmission**

- 1 - T-piece
- 2 - 590-mm steel flexi-pipe
- 3 - 750-mm Tekalan line
- 4 - Protective tube
- 5 - Change-over valve
- 6 - 170-mm vacuum line

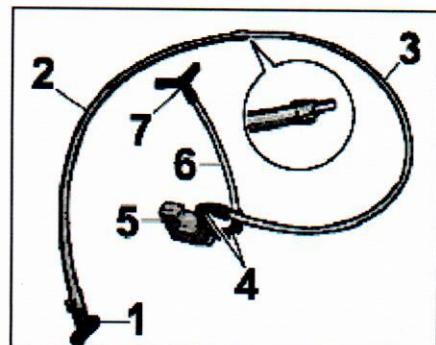

7 - Y-piece

Cut 750-mm **-3-** and 170-mm lengths **-6-** off the supplied Tekalan line.

Fit 590-mm steel flexi-pipe **-2-** and 750-mm Tekalan line **-3-** together.

Fit 590-mm steel flexi-pipe **-2-** into the T-piece **-1-** .

Insert 750-mm Tekalan line and 170-mm Tekalan line at least 10 mm into the protective tubes **-4-** .

Fit 170-mm Tekalan line **-6-** into the Y-piece.

Fit protective tubes on change-over valve **-5-** .

**Information**

Insert vacuum line at least 10 mm into the steel flexi-pipe.

5.1.2 Vehicles with Porsche Doppelkupplung (PDK)

1 - T-piece

2 - 590-mm steel flexi-pipe

3 - 595-mm Tekalan line

4 - Protective tube

5 - Change-over valve

6 - 225-mm Tekalan line

7 - Distributing piece, 4-way

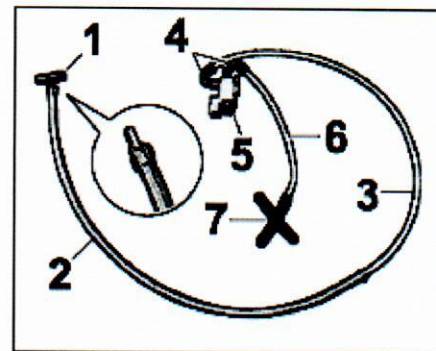

Figure 26

Cut 595-mm **-3-** and 225-mm lengths **-6-** off the supplied Tekalan line.

Fit 590-mm steel flexi-pipe **-2-** and 595-mm Tekalan line **-3-** together.

Fit 590-mm steel flexi-pipe **-2-** into the T-piece **-1-** .

Insert 595-mm Tekalan line and 225-mm Tekalan line at least 10 mm into the protective tubes **-4-** .

Fit 225-mm Tekalan line into the 4-way distributing piece **-7-** .

Fit protective tubes on change-over valve **-5-** .

**Information**

Insert vacuum line at least 10 mm into the steel flexi-pipe.

5.2 Lock single-lug clip -1-

Fit fixing clip **-2-** at the marked position (black) on the steel

flexi-pipe.

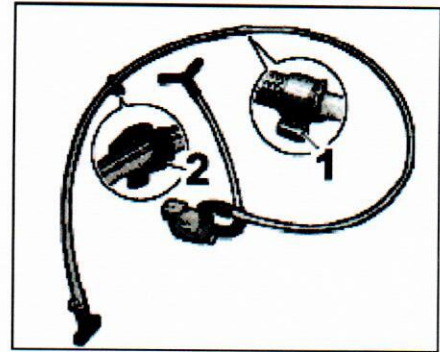

Figure 27

6 Install vacuum lines.



Information

The wire harness for the change-over valve is incorporated as standard in the engine wire harness and is secured to the cable duct with wrapping tape.

6.1 Expose wire harness for change-over valve **-arrow-** .

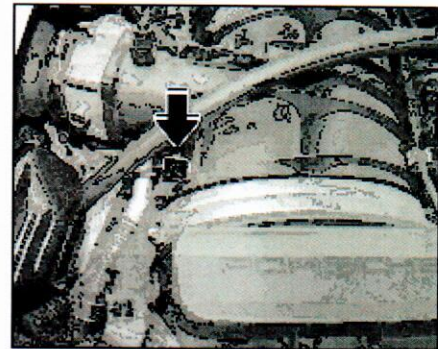

Figure 28

6.2 Install change-over valve holder.

6.2.1 Loosen Torx screw **-1-** on the intake bridge.

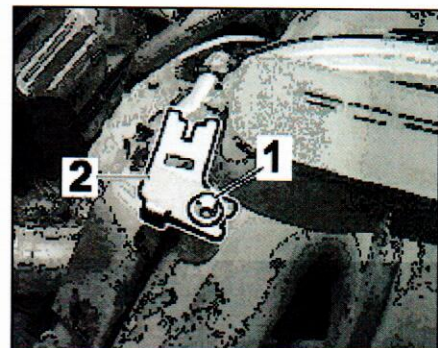

Figure 29

6.2.2 Slide change-over valve holder **-2-** under the Torx screw and tighten Torx screw.

6.3 Slide change-over valve **-1-** onto the change-over valve

holder. Route the longer vacuum line **-3-** along the shift cable **-4-** and down to the transmission **-arrow b-**.

Pull off dummy plug on change-over valve connector.

Connect plug connection **-arrow a-**.

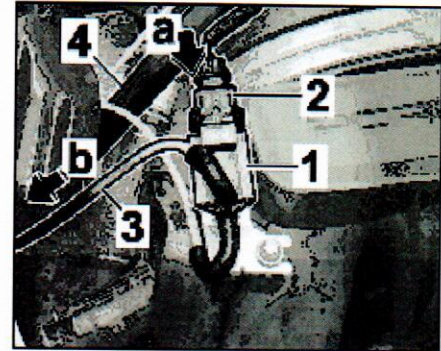

Figure 30

6.4 **Only** for vehicles with PDK:
Connect vacuum lines for change-over valve.

6.4.1 Pull Y-piece **-1-** off the standard change-over valve **-2-**.

5 - Throttle valve

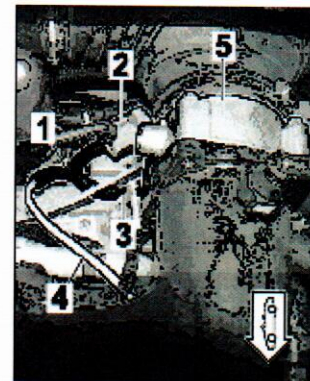

Figure 31

6.4.2 Pull Tekalan line (vacuum line on engine side) **-4-** and Tekalan line (vacuum line on transmission side) **-3-** out of the Y-piece **-1-**.

6.4.3 Insert Tekalan line (vacuum line on engine side) **-4-**, Tekalan line (vacuum line on transmission side) **-3-** and Tekalan line (vacuum line for change-over valve for sports exhaust system) **-5-** at least 10 mm into the 4-way distributing piece.

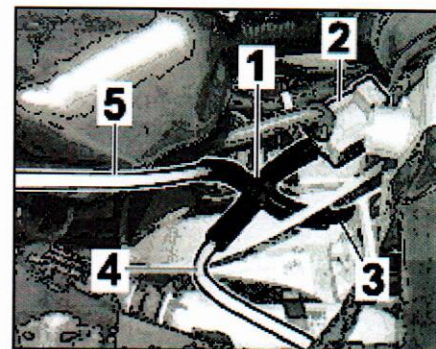

Figure 32

6.4.4 Fit 4-way distributing piece **-1-** on the standard change-over valve **-2-**.

6.5 **Only** for vehicles with manual transmission:
Connect vacuum lines for change-over valve.

6.5.1 Pull Tekalan line (vacuum line on engine side) **-1-** and Tekalan line (vacuum line on transmission side) **-2-** out of the connecting piece **-3-**.

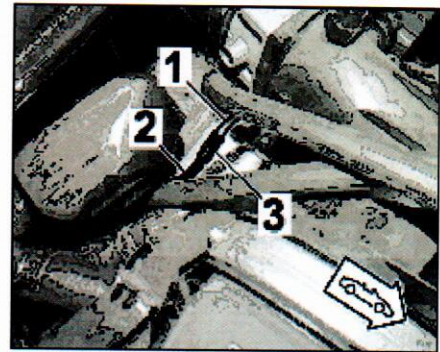

Figure 33

- 6.5.2 Insert Tekalan line (vacuum line on engine side) **-2-**, Tekalan line (vacuum line on transmission side) **-3-** and Tekalan line (vacuum line for change-over valve for sports exhaust system) **-4-** at least 10 mm into the Y-piece **-1-**.

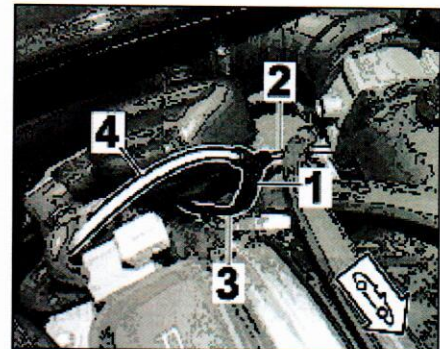

Figure 34



Information

The vacuum line is routed correctly if the T-piece is touching the rear support **rear arrow**.

- 6.6 Fit fixing clip **-arrow-** in the pocket before the third cross strut on the transmission.

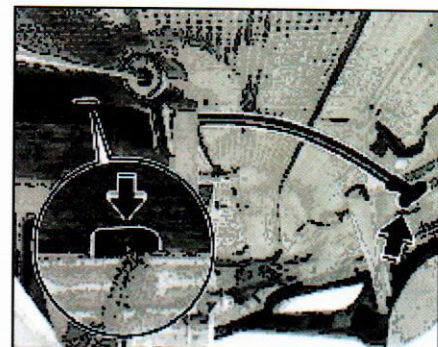

Figure 35

- 7 Install new rear silencers. → 263319 *Removing and installing rear silencer*
- 8 Secure vacuum lines in the rear support area.
- 8.1 Fit four fixing clips **-1-** on rear support **-2-**. Check spacing!
- a - 155 mm
 - b - 48 mm

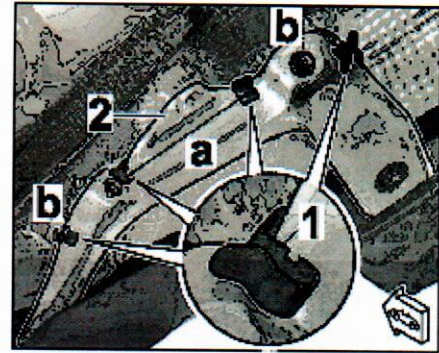

Figure 36

8.2 Join steel flexi-pipes from the rear silencers and T-piece.



Information

Steel flexi-pipe follows the inner contour of the rear support ⇒ Figure 37 **-arrows-**.

Fit steel flexi-pipe **-2-** into the clips **-1-** .

- ✓ - Position of steel flexi-pipe is **OK**
- X - Position of steel flexi-pipe is **not OK**

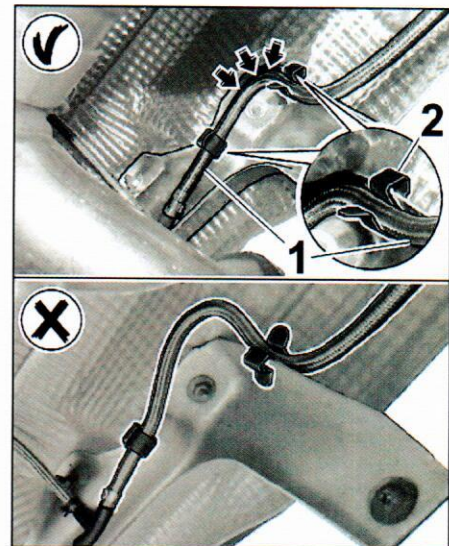

Figure 37



Information

The steel flexi-pipe should only be barely visible in the air outlet area.

8.3 Fit steel flexi-pipe in the fixing clips and check that the steel flexi-pipe is not hanging down from the rear apron in the air outlet area.

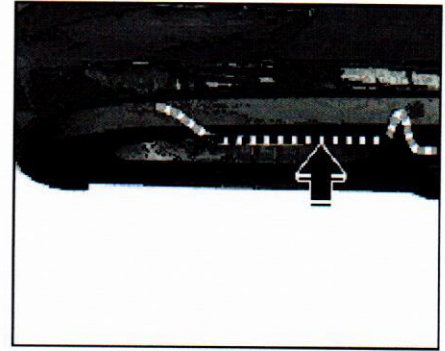

Figure 38

- 9 **Only** for vehicles with manual transmission:
Fit the holders -1- on the coolant hoses.
Clip 750-mm Tekalan line -2- into the holder.



Figure 39

- 10 Concluding work.
- 10.1 Install rear luggage compartment trim panel. → 700619 *Removing and installing rear luggage compartment trim panel*
- 10.2 Install engine compartment lid. → 557819 *Removing and installing engine compartment lid*
- 10.3 Install trim panel for rear-wall sound absorber. → 703119 *Removing and installing trim panel for rear wall*
- 10.4 Install side trim panel at the left. → 707519 *Removing and installing side trim panel*
- 10.5 Secure the seat belt mount in the B-pillar sill area.
- 10.5.1 Guide the belt at the left of the door sill -A- and turn the seat belt mount 180 degrees (clockwise) -B- .

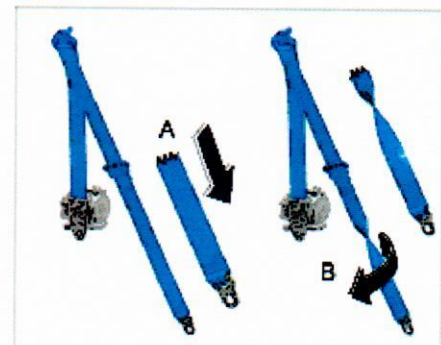

Figure 40

- 10.5.2 Guide cheese head bolt **-2-** through the seat belt mount **-3-** and spacer sleeve **-4-** and secure it.
→ **Tightening torque: 50 Nm (37 ftlb.)**

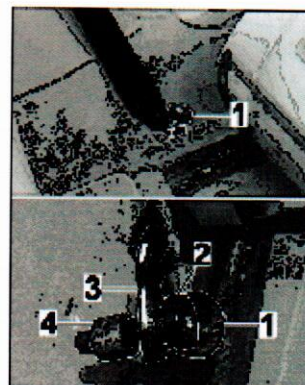

Figure 41

- 10.5.3 Close the cap **-1-**.

WARNING

Incorrect handling of safety bolts

- **Danger of injury**
- **Loss of torque**

- Always use new fastening screws and nuts following removal.
- Observe specified tightening torques.
- Carry out a visual inspection of all re-used parts.

10.6 Install left front seat. → *720119 Removing and installing front seat*

10.7 Install inner door sill trim at the left. → *680519 Removing and installing inner door sill trim*

10.8 Move convertible top out of service position. → *6101IN Convertible-top service position*

10.9 Convert switch console.

10.9.1 Remove switch console. → *962719 Removing and installing switch console*



Information

The switch console consists of a total of 16 buttons, 10 light guides and 10 trims. Each half can be used for the left or right row of the main body.

10.9.2 Assemble new switch console in accordance with the new vehicle equipment.

Fit light guide at the correct side **-1-** in the main body
-arrow-.

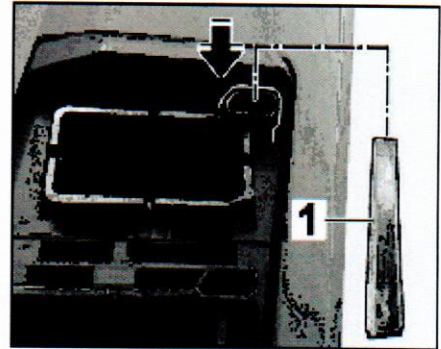

Figure 42

Fit trim **-1-** underneath the button in the main body **-arrows-** .

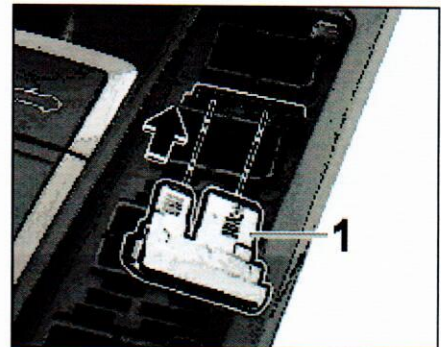

Figure 43

Position button **-1-** and clip it into the main body **-arrow-** .

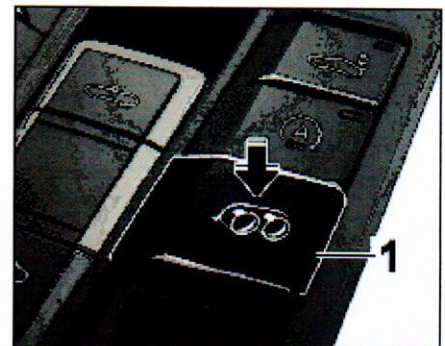

Figure 44

10.9.3 Install switch console. → 962719 *Removing and installing switch console*

NOTICE

Voltage drop

- Risk of irreparable damage to control unit
- Risk of damage to control unit
- Fault entries in the control unit
- Coding in the control unit is aborted
- Malfunctions in control unit, even during programming

→ Prior to disconnecting the control unit, switch off ignition and remove ignition key.

→ Ensure that the power supply is not interrupted during programming.

- Connect a battery charger with a current rating of at least → **Nominal value: 40 A** to the vehicle battery.



Information

The **PIWIS Tester 3 9900** instructions take precedence since the description may be different with later Tester releases.

The procedure described here has been structured in general terms. Different text or additional information may appear in **PIWIS Tester 3 9900**.

11 Code sports exhaust system.

11.1 **PIWIS Tester II 9818** must now be connected and the ignition switched on.

11.2 Select the required vehicle type. PIWIS Tester Diagnostics starts.



Information

The sports exhaust system button can only be coded on the right-hand side of the switch console.

11.3 Code keypad assignment. → *962755 Replacing switch console*

11.4 Maintenance of vehicle data

11.4.1 **Additional menu** must now be selected by pressing F7.

11.4.2 Select the **Maintenance of vehicle data** function. Press F12 until **X numbers** appears in the Value group column.

11.4.3 Select **XLF - Sports exhaust system** in the Coding value column. When you touch the Installed cell, a tick appears.

11.4.4 Save the values by pressing F8. Wait until the message **Modified values have been buffered** appears.

11.4.5 Press F12 until F8 can be activated.

11.4.6 Press F8 to write values. Wait until the message **Generation of vehicle data is complete** appears.

11.4.7 Press F12 to switch to Report management. Open the log by pressing F10 and check that vehicle equipment **XLF Sports exhaust system** is displayed.

11.5 Adapt coding.

11.5.1 Press F11 to return to the list of control units.
Select all control units.

- 11.5.2 Switch to the **Codings/adaptations** menu.
Select **Automatic coding**. Press **F12** to continue.
Wait until the message **Coding has been completed successfully** appears. Press **F12** to continue.
- 11.6 Read out the fault memories of all systems, work through any existing faults and erase the fault memories. → *033500 Fault memory for on-board diagnosis*
- 11.7 Carry out "Sports exhaust system" function test.

Start the vehicle. The exhaust flaps open when you press the "Twin tailpipe" button. The noise of the exhaust motor can be heard.

- 11.8 Disconnect battery charger. → *2X00IN Battery trickle charging*

26013100:

Sports exhaust system installed; Labour time **480 ZE**

Includes Removing and installing rear silencers and strip for switches, coding sports exhaust system.

981320, 981321, 981330, 981331, 981360, 981361

Model year as of 2013

C00, C05, C06, C07, C08, C09, C10, C11, C12, C13, C14, C15, C16, C17, C18, C19, C20, C21, C22, C23, C24, C25, C26, C27, C28, C32, C33, C34, C35, C37, C38, C39, C41, C45, C46, C96, C97, C98, C99